

# JUROP R150, R200 & R260 PARTS LAYOUT

## JUROP R SERIES PARTS LAYOUT

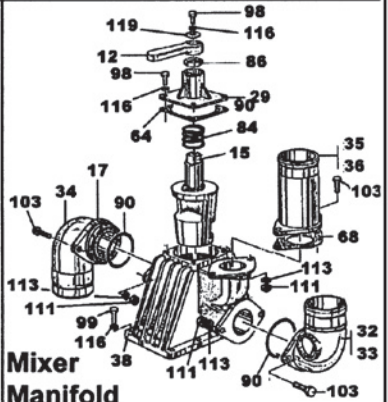
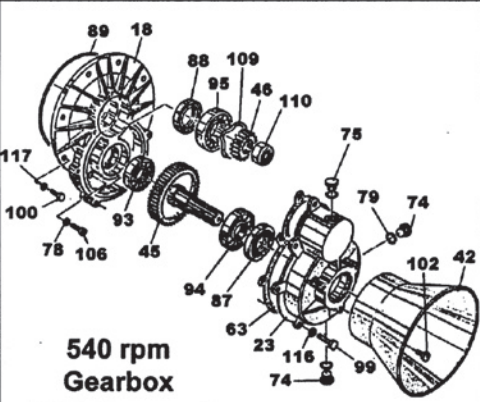
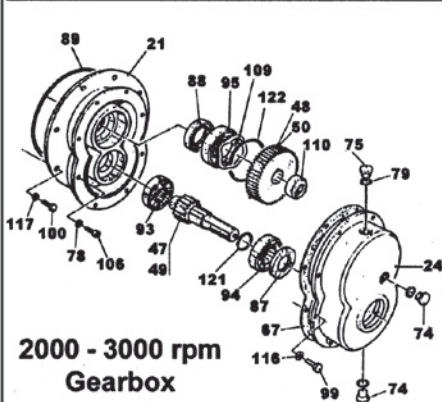
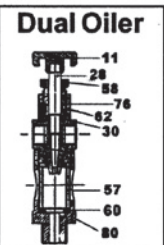
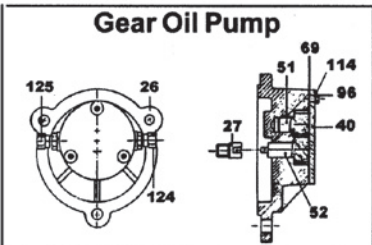
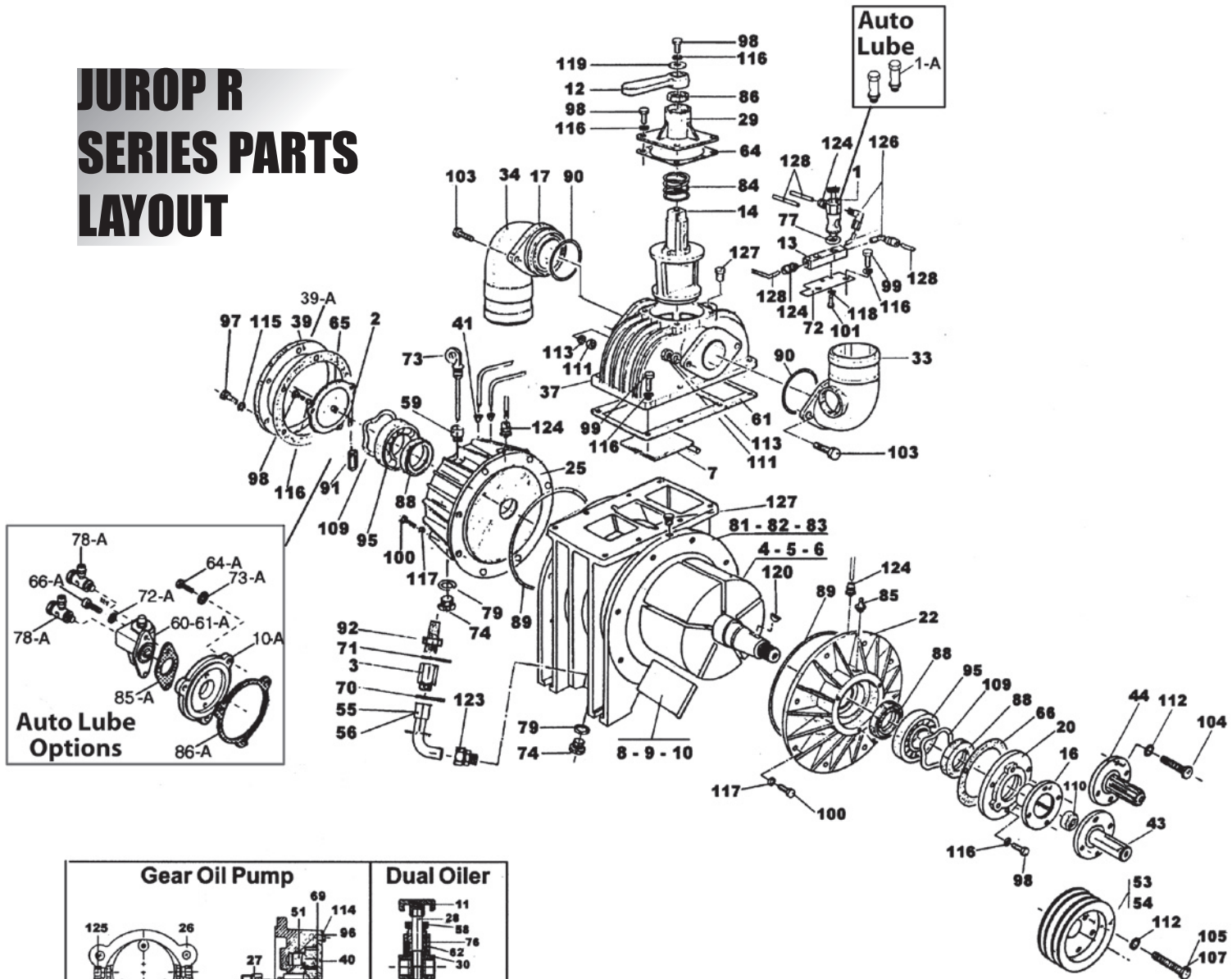

# JUROP R150, R200 AND R260 REPLACEMENT PARTS

POS.	PART#	DESCRIPTION
1	1401200400	OILER FOR PN & R
1-A	1401200700	OIL DRIPPER AUTOMATIC LUBRICATION
2	1407200500	GEAR OIL PUMP FOR PN & R
3	1493300200	BALLAST VALVE 1/2"
4	1521500700	ROTOR R150
5	1521500800	ROTOR R200
6	1521500900	ROTOR R260
7	1593600000	FLAPPER VALVE FOR PN, R & PR620
8	1601600700	VANE R150 (5 REQUIRED)
9	1601600900	VANE R200 (5 REQUIRED)
10	1601601100	VANE R260 (5 REQUIRED)
10-A	1610508500	AUTOMATIC LUBRICATION PUMP FLANGE R-PNR-PNE
11	1605200000	REGULATOR NUT FOR OILER
12	1605500000	HANDLE FOR VALVE STEM
13	1608100000	OILER MANIFOLD
14	1608500000	VALVE COCK - NORMAL
15	1608500100	VALVE COCK - MIXER
16	1610006600	ROTOR FLANGE
17	1610100000	FLANGE FOR ELBOW HOSE CONN.
18	1610500000	END PLATE 540
19	1610500200	END PLATE 2000 - 3000 RPM
20	1610500400	END CAP FOR END PLATE
21	1610501200	END PLATE 2000 - 3000 RPM
22	1610501300	END PLATE FOR R150 - R200 - R260
23	1612100000	ALUMINUM COVER 540 RPM
24	1612500000	COVER FOR 2000 - 3000 RPM
25	1612500300	OIL RESERVOIR R150, R200, & R260
26	1613500100	OIL PUMP HOUSING
27	1622002600	OIL PUMP PIVOT
28	1622200200	PIVOT FOR OILER
29	1623100000	VALVE STEM HOUSING
30	1623200000	OILER HEAD
31	1623200100	OILER HEAD
32	1627100100	60MM ELBOW WITH RELIEF HOLE
33	1627100200	76MM ELBOW WITH RELIEF HOLE
34	1627100500	76MM ELBOW HOSE CONNECTION
35	1627100700	60MM STRAIGHT HOSE CONN.
36	1627100800	76MM STRAIGHT HOSE CONN.
37	1627500000	VALVE HOUSING - NORMAL
38	1627500100	VALVE HOUSING - MIXER
39	1640100000	COVER FOR RESERVOIR
39-A	1640100700	COVER FOR RESERVOIR-AUTO LUBRICATION PUMP R SERIES
40	1640200000	END PLATE FOR OIL PUMP
41	1642600000	OIL LINE RUBBER GASKET
42	1642600100	PTO SHIELD
43	1650004300	SMOOTH SHAFT
44	1650004700	SPLINE SHAFT
45	1651000000	DRIVE GEAR 540 RPM
46	1651000100	PINION GEAR 540 RPM
47	1651000400	GEAR 2:1 20 TOOTH
48	1651000500	GEAR 2:1 39 TOOTH
49	1651000600	GEAR 3:1 16 TOOTH
50	1651000700	GEAR 3:1 43 TOOTH
51	1651001300	COMPANION GEAR FOR OIL PUMP
52	1651001400	DRIVE GEAR FOR OIL PUMP
53	1653500900	8" PULLEY - 4 GROOVE
54	1653501000	6" PULLEY - 4 GROOVE
55	1663013900	BALLAST TUBE R200 - R260
56	1663014000	BALLAST TUBE R150
57	1663600100	SIGHT GLASS FOR OILER
58	1670200100	LOCKING NUT FOR OILER
59	1673004100	EXTENSION
60	1680600000	GASKET FOR OILER
60-A	4024251000	AUTOMATIC LUBRICATING PUMP(CW ROTATION)
61	1680600100	GASKET FOR VALVE HOUSING
61-A	4024251500	AUTOMATIC LUBRICATING PUMP(CCW ROTATION)
62	1680603500	GASKET FOR OILER
63	1680700000	GASKET
64	1680700200	GASKET FOR VALVE STEM HOUSING
64-A	4026107110	SCREW M8 X 25

POS.	PART#	DESCRIPTION
65	1680700300	COVER GASKET FOR RESERVOIR
66	1680700400	GASKET FOR END CAP
66-A	4026120304	SCREW M6 X 16
67	1680700500	GASKET 2000-3000 RPM GEARBOX
68	1680700600	GASKET FOR FLANGE
69	1680702900	END PLATE GASKET
70	1681003800	BRACKET R200-260
71	1681004000	BRACKET R150
72	1681100000	OILER MOUNT PLATE
72-A	4026350908	WASHER M6
73	1683600300	DIP STICK
73-A	4026350909	WASHER M8
74	1684000000	DRAIN PLUG 3/8"
75	1684000100	VENT PLUG 3/8"
76	1685001500	WASHER FOR OILER
77	1685100000	WASHER FOR OILER
78	1685100100	FLAT WASHER 10MM
78-A	4026706101	FITTING Ø4-1/8"
79	1685100200	WASHER 17MM FOR DRAIN PLUG
80	1687200100	OILER BODY
81	1687500800	PUMP HOUSING R150
82	1687500900	PUMP HOUSING R200
83	1687501000	PUMP HOUSING R260
84	1691000000	VALVE SPRING
85	4022100010	GREASE FITTING
85-A	1680609700	OIL PUMP GASKET
86	4022200030	SEAL FOR VALVE STEM HOUSING
86-A	1680609800	OIL PUMP FLANGE GASKET
87	4022200040	SEAL FOR GEARBOX COVER
88	4022200110	SHAFT SEAL
89	4022200240	O-RING FOR RESERVOIR AND END PLATE
90	4022200250	O-RING FOR ELBOW
91	4022300001	FILTER FOR OIL PUMP
92	4022301004	BALLAST FILTER
93	4023100020	BEARING
94	4023100030	BEARING
95	4023100040	BEARING FOR END PLATE & RESERVOIR
96	4026100204	BOLT 5X16MM
97	4026100304	BOLT 6X16MM
98	4026100408	BOLT 8X20MM
99	4026100410	BOLT 8X25MM
100	4026100510	BOLT 10X25MM
101	4026101301	BOLT 6X10MM
102	4026101403	BOLT 8X10MM
103	4026101613	BOLT 12X40MM
104	4026107215	FLANGE BOLT
105	4026108607	BOLT 10X55MM
106	4026120505	ALLEN BOLT 10X25MM
107	4026120513	BOLT 10X70MM
108	4026120518	BOLT 10X100MM
109	4026300020	WAVE RING
110	4026305614	LOCKNUT FOR FLANGE 24X2MM
111	4026308007	NUT 12MM FOR ELBOW FLANGE
112	4026350608	LOCK WASHER 10.5MM
113	4026350609	LOCK WASHER 13MM FOR ELBOW FLANGE
114	4026350907	WASHER 5MM
115	4026350908	WASHER 6.4MM
116	4026350909	LOCK WASHER 8.4MM
117	4026350910	TOOTH WASHER 8.5MM
118	4026351504	TOOTH WASHER 6.4MM
119	4026356004	FLAT WASHER 8MM
120	4026500018	WOODRUFF KEY
121	4026510030	SNAP RING 40MM
122	4026510547	SNAP RING 90MM
123	4026701301	FITTING 1/2" X 18
124	4026702000	OIL LINE FITTING
125	4026702004	OIL LINE FITTING
126	4026706000	90° OIL LINE FITTING
127	4026905002	PLUG 1/4"
128	4033200002	OIL LINE (PER 5 FOOT)